

## Low voltage current transformers for industrial applications Wound current transformers

---

<b>WSK 30</b>	Transformer width	61 mm
---------------	-------------------	-------

---

<b>WSK 40</b>	Transformer width	71 mm
---------------	-------------------	-------

---

<b>WSK 40 N</b>	Transformer width	71 mm
-----------------	-------------------	-------

***NEW***

---

<b>WSK 60</b>	Transformer width	71 mm
---------------	-------------------	-------

---

<b>WSK 70.6</b>	Transformer width	60 mm
-----------------	-------------------	-------

---

<b>WSK 70.6 N</b>	Transformer width	60 mm
-------------------	-------------------	-------

---

<b>WSK 31.5</b>	Transformer width	70 mm
-----------------	-------------------	-------

---

## Wound current transformers

Based on the physical operating principle of current transformers, the required core volume transferring an amount of power, increases rapidly with a decreasing nominal current. As there are limits on increasing the transformer size, wound current transformers are being used.

Interim current transformers also belong to the group of wound current transformers. This construction is mainly used for primary currents of up to 10 A, and achieves a transformation at a higher or lower secondary current values. In addition to their application in adapting a measuring circuit on existing measuring units, interim current transformers are being used also for lowering the power loss by the transmission of analogically measured values over great distances. This is made possible by means of a squared dependence of the power loss from the flowing current.

$$P_V = I^2 \times Z \text{ [VA]}$$

apparent power [VA]

This means when the original nominal current is halved, the conductor loss drops down to 25 % of its original value.

Indication: The selection of the nominal power of the initially activated main transformer is achieved through the application of the following measurement comparisons.

$$P_{GH} = P_Z \times \left( \frac{I_2}{I_1} \right)^2 + P_E + P_{HZ}$$

$P_{GH}$  apparent power of the main transformer

$P_Z$  secondary performance of the interim transformer (nominal performance inclusive of conductor losses)

$P_E$  consumption of the interim transformer by nominal current

$P_{HZ}$  conductor losses between main- and interim transformer by nominal current

$I_1$  primary nominal current of the interim transformer

$I_2$  secondary nominal current of the interim transformer



# WSK 30

Wound current transformer

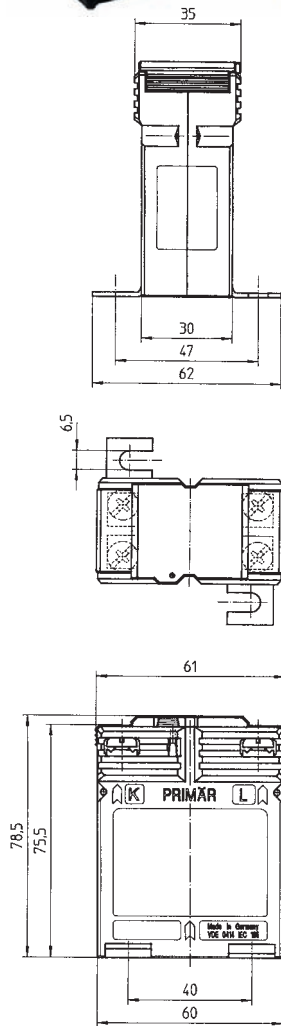

Secondary current		5A		1A	
Primary current A	Burden VA	Accuracy class		Accuracy class	
		1	0.5	1	0.5
		Art.-no.	Art.-no.	Art.-no.	Art.-no.
1	2.5	30017	30011	30217	30211
	5	30018		30218	
2.5	2.5	30019	30012	30219	30212
	5	30020		30220	
5	2.5	30021	30013	30221	30213
	5	30022		30222	
10	2.5	30023	30014	30223	30214
	5	30024		30224	
15	2.5	30025	30015	30225	30215
	5	30026		30226	
20	2.5	30027	30016	30227	30216
	5	30028		30228	

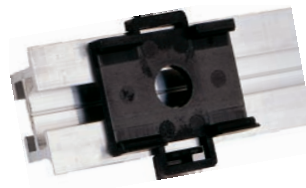

Snap-on mounting

Primary conductor	—
Round conductor	—
Transformer width	61 mm
Snap-on mounting	<b>Art.-no. 53011</b> see page 204
Sealed shutter	<b>Art.-no. 59040</b> see page 205



# WSK 40

Wound current transformer

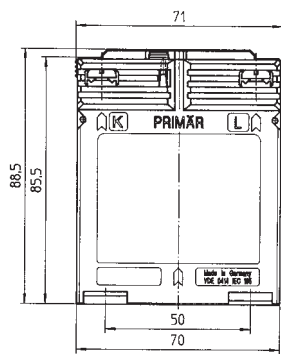
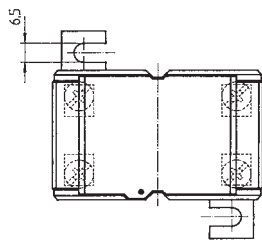
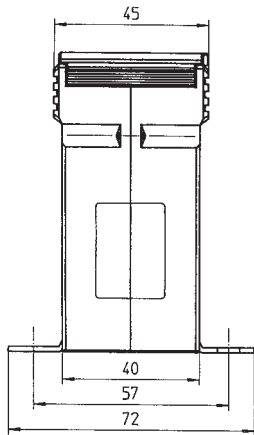

Secondary current		5A		1A	
Primary current A	Burden VA	Accuracy class		Accuracy class	
		1	0.5	1	0.5
		Art.-no.	Art.-no.	Art.-no.	Art.-no.
1	2.5	31044	31011	31244	31211
	5	31045	31012	31245	31212
	10	31046	31013	31246	31213
	15	31047	31014	31247	31214
2.5	2.5	31048	31015	31248	31215
	5	31049	31016	31249	31216
	10	31050	31017	31250	31217
	15	31051	31018	31251	31218
5	2.5	31052	31019	31252	31219
	5	31053	31020	31253	31220
	10	31054	31021	31254	31221
	15	31055	31022	31255	31222
10	2.5	31056	31023	31256	31223
	5	31057	31024	31257	31224
	10	31058	31025	31258	31225
	15	31059	31026	31259	31226
15	2.5	31060	31027	31260	31227
	5	31061	31028	31261	31228
	10	31062	31029	31262	31229
	15	31063	31030	31263	31230
20	2.5	31064	31031	31264	31231
	5	31065	31032	31265	31232
	10	31066	31033	31266	31233
	15	31067	31034	31267	31234
25	2.5	31068	31035	31268	31235
	5	31069	31036	31269	31236
	10	31070	31037	31270	31237
	15	31071	31038	31271	31238
30	2.5	31072	31039	31272	31239
	5	31073	31040	31273	31240
	10	31074	31041	31274	31241

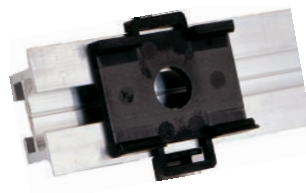

Snap-on mounting

Primary conductor	—
Round conductor	—
Transformer width	71 mm
Snap-on mounting	<b>Art.-no. 55012</b> see page 204
Sealed shutter	<b>Art.-no. 59041</b> see page 205



# WSK 40 N

Wound current transformer

Primary current A	Burden VA	5A		1A	
		Accuracy class		Accuracy class	
		1	0.5	1	0.5
		Art.-no.	Art.-no.	Art.-no.	Art.-no.
30	2.5	31161	31151	31361	31351
	5	31162	31152	31362	31352
	10	31163	31153	31363	31353
40	2.5	31164	31154	31364	31354
	5	31165	31155	31365	31355
	10	31166	31156	31366	31356
50	2.5	31167	31157	31367	31357
	5	31168	31158	31368	31358
	10	31169	31159	31369	31359

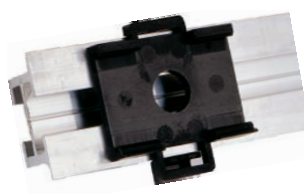
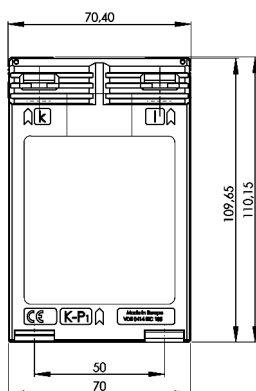
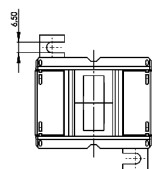
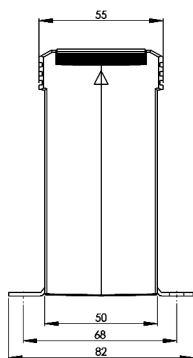

Snap-on mounting

Primary conductor	—
Round conductor	—
Transformer width	71 mm
Snap-on mounting	<b>Art.-no. 55011</b> see page 204
Sealed shutter	<b>Art.-no. 59041</b> see page 205



# WSK 60

## Wound current transformer

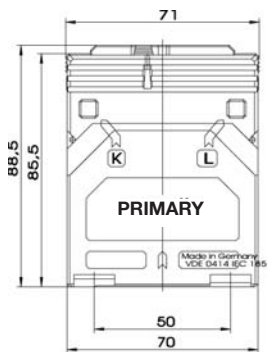
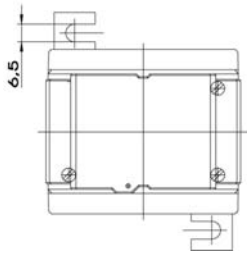
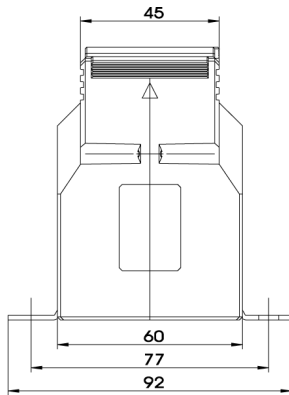

Secondary current		5A		1A	
Primary current A	Burden VA	Accuracy class		Accuracy class	
		1	0.5	1	0.5
		Art.-no.	Art.-no.	Art.-no.	Art.-no.
5	2.5	35041	35011	35241	35211
	5	35042	35012	35242	35212
	10	35043	35013	35243	35213
	15	35044		35244	
10	2.5	35045	35014	35245	35214
	5	35046	35015	35246	35215
	10	35047	35016	35247	35216
	15	35048		35248	
15	2.5	35049	35017	35249	35217
	5	35050	35018	35250	35218
	10	35051	35019	35251	35219
	15	35052		35252	
20	2.5	35053	35020	35253	35220
	5	35054	35021	35254	35221
	10	35055	35022	35255	35222
	15	35056		35256	
25	2.5	35057	35023	35257	35223
	5	35058	35024	35258	35224
	10	35059	35025	35259	35225
	15	35060		35260	
30	2.5	35061	35026	35261	35226
	5	35062	35027	35262	35227
	10	35063	35028	35263	35228
	15	35064		35264	

Primary conductor	—
Round conductor	—
Transformer width	71 mm
Snap-on mounting	—
Sealed shutter	<b>Art.-no. 59041</b> see page 205

# WSK 70.6

## Wound current transformer

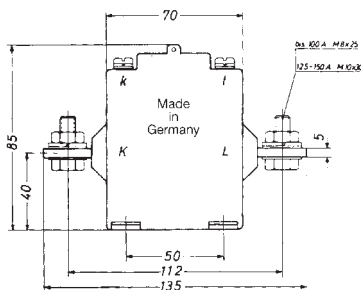
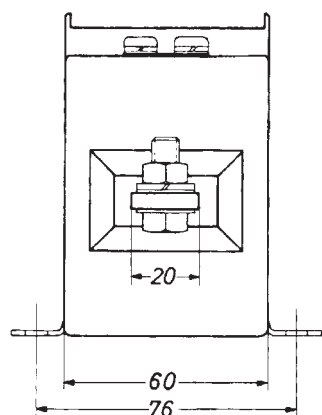

Secondary current		5A		1A	
Primary current A	Burden VA	Accuracy class		Accuracy class	
		1	0.5	1	0.5
		Art.-no.	Art.-no.	Art.-no.	Art.-no.
25	2.5	32038	32011	32238	32211
	5	32039	32012	32239	32212
	10	32040	32013	32240	32213
	15	32041		32241	
30	2.5	32042	32014	32242	32214
	5	32043	32015	32243	32215
	10	32044	32016	32244	32216
	15	32045		32245	
40	2.5	32046	32017	32246	32217
	5	32047	32018	32247	32218
	10	32048	32019	32248	32219
	15	32049		32249	
50	2.5	32050	32020	32250	32220
	5	32051	32021	32251	32221
	10	32052	32022	32252	32222
	15	32053		32253	
60	2.5	32054	32023	32254	32223
	5	32055	32024	32255	32224
	10	32056	32025	32256	32225
	15	32057		32257	
75	2.5	32058	32026	32258	32226
	5	32059	32027	32259	32227
	10	32060	32028	32260	32228
	15	32061		32261	
80	2.5	32062	32029	32262	32229
	5	32063	32030	32263	32230
	10	32064	32031	32264	32231
	15	32065		32265	
100	2.5	32066	32032	32266	32232
	5	32067	32033	32267	32233
	10	32068	32034	32268	32234
	15	32069		32269	

Primary conductor	—
Round conductor	—
Transformer width	60 mm
Snap-on mounting	—
Sealed shutter	<b>Art.-no. 59043</b> see page 205



# WSK 70.6 N

Wound current transformer

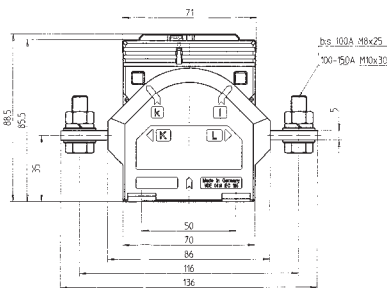
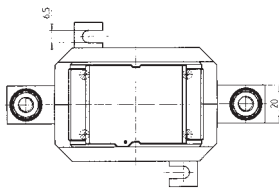
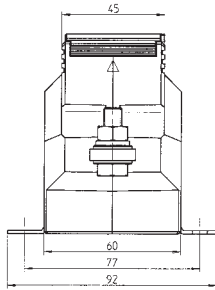

Secondary current		5A		1A	
Primary current A	Burden VA	Accuracy class		Accuracy class	
		1	0.5	1	0.5
		Art.-no.	Art.-no.	Art.-no.	Art.-no.
25	2.5	89047	89011	89247	89211
	5	89048	89012	89248	89212
	10	89049	89013	89249	89213
	15	89050		89250	
30	2.5	89051	89015	89251	89215
	5	89052	89016	89252	89216
	10	89053	89017	89253	89217
	15	89054		89254	
40	2.5	89055	89019	89255	89219
	5	89056	89020	89256	89220
	10	89057	89021	89257	89221
	15	89058		89258	
50	2.5	89059	89023	89259	89223
	5	89060	89024	89260	89224
	10	89061	89025	89261	89225
	15	89062		89262	
60	2.5	89063	89027	89263	89227
	5	89064	89028	89264	89228
	10	89065	89029	89265	89229
	15	89066		89266	
75	2.5	89067	89031	89267	89231
	5	89068	89032	89268	89232
	10	89069	89033	89269	89233
	15	89070		89270	
80	2.5	89071	89035	89271	89235
	5	89072	89036	89272	89236
	10	89073	89037	89273	89237
	15	89074		89274	
100	2.5	89075	89039	89275	89239
	5	89076	89040	89276	89240
	10	89077	89041	89277	89241
	15	89078		89278	

Primary conductor	—
Round conductor	—
Transformer width	60 mm
Snap-on mounting	—
Sealed shutter	<b>Art.-no. 59041</b> see page 205



# WSK 31.5

## Wound current transformer

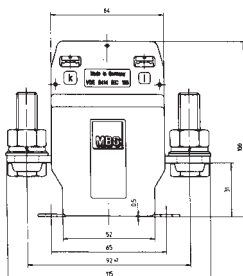
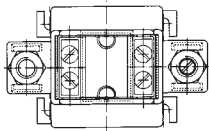
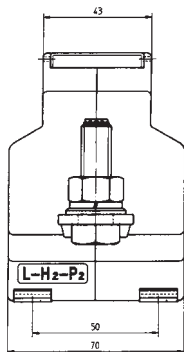
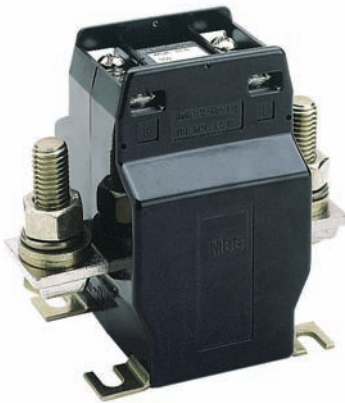

Secondary current	Primary current	Burden VA	5A		1A	
			Accuracy class		Accuracy class	
			1	0.5	1	0.5
	A	VA	Art.-no.	Art.-no.	Art.-no.	Art.-no.
25	25	2.5	33047	33011	33247	33211
		5	33048	33012	33248	33212
		10	33049	33013	33249	33213
		15	33050	33014	33250	33214
30	30	2.5	33051	33015	33251	33215
		5	33052	33016	33252	33216
		10	33053	33017	33253	33217
		15	33054	33018	33254	33218
40	40	2.5	33055	33019	33255	33219
		5	33056	33020	33256	33220
		10	33057	33021	33257	33221
		15	33058	33022	33258	33222
50	50	2.5	33059	33023	33259	33223
		5	33060	33024	33260	33224
		10	33061	33025	33261	33225
		15	33062	33026	33262	33226
60	60	2.5	33063	33027	33263	33227
		5	33064	33028	33264	33228
		10	33065	33029	33265	33229
		15	33066	33030	33266	33230
75	75	2.5	33067	33031	33267	33231
		5	33068	33032	33268	33232
		10	33069	33033	33269	33233
		15	33070	33034	33270	33234
80	80	2.5	33071	33035	33271	33235
		5	33072	33036	33272	33236
		10	33073	33037	33273	33237
		15	33074	33038	33274	33238
100	100	2.5	33075	33039	33275	33239
		5	33076	33040	33276	33240
		10	33077	33041	33277	33241
		15	33078	33042	33278	33242
150	150	2.5	33079	33043	33279	33243
		5	33080	33044	33280	33244
		10	33081	33045	33281	33245
		15	33082	33046	33282	33246

Primary conductor	—
Round conductor	—
Transformer width	70 mm
Snap-on mounting	—
Sealed shutter	<b>Art.-no. 59045</b> see page 205
Current transformer for tariff applications	see page 194